

Industry Breakthrough

Dynamic SPECT Acquisition

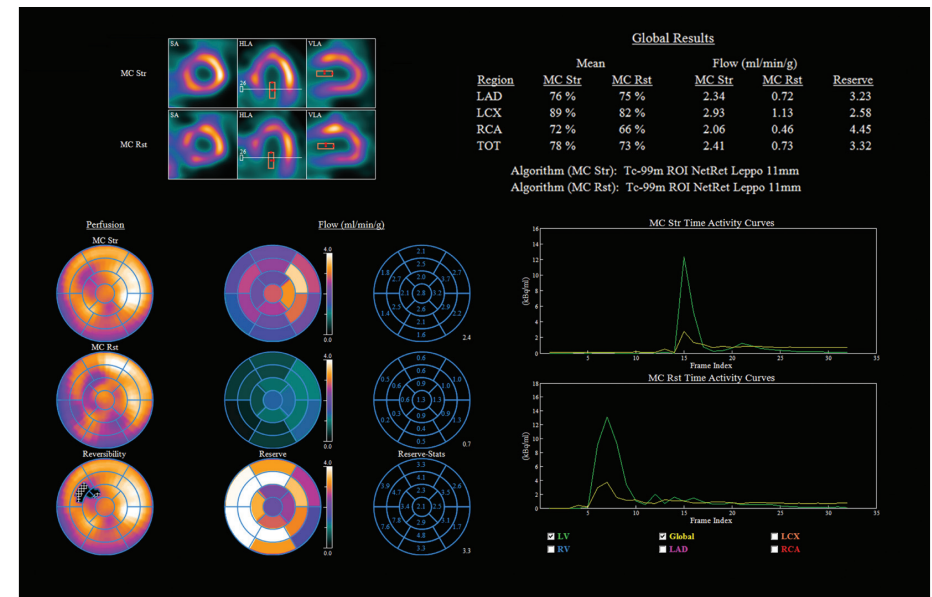

SPECTRUM
DYNAMICS MEDICAL



Quantifying Myocardial Blood Flow

D-SPECT[®]
CARDIO

Nuclear Cardiology in the 21st Century

In the 21st century, most nuclear cameras are still relying on a technology invented in the 1950's (crystals and vacuum tubes). Spectrum Dynamics Medical changed all that several years ago with the introduction of the first clinical Cadmium Zinc Telluride (CZT) based nuclear cardiac imaging system – the D-SPECT® and now the next generation, D-SPECT® Cardio.

D-SPECT Cardio Features:

Benefits:

Flexibility to image supine, upright, and anything in between	→ Image even the most technically challenging patients
Chair/bed weight supports patients up to 1000 lb/454 kg	→ Ability to image morbidly obese patients
Open design with no gantry motion	→ Eliminates claustrophobia & reduces chance of patient motion
Small camera footprint	→ Ideal for facilities with rooms as small as 9'5" x 11' (2.9m x 3.3 m)
Detector sensitivity up to 10x that of conventional cameras	→ Shorter imaging time, dose reduction, & ability to quantify coronary blood flow
Nine columns of CZT detectors with Tungsten collimators	→ Opens the door to new clinical applications
Innovative proprietary reconstruction algorithm	→ Exceptional image resolution and quality



Dynamic SPECT...

A Breakthrough in Nuclear Cardiac Imaging

Gated SPECT acquisitions have been the mainstay of nuclear cardiac imaging for the last two decades, serving as a non-invasive way to image perfusion and wall motion. Despite improvements in quantitative software over the years, novel applications that provide clinicians with clinically significant diagnostic information simply have not been available, until now.

D-SPECT Cardio's unique implementation of CZT and reconstruction software lays the foundation for Dynamic SPECT acquisitions. The D-SPECT Cardio rapidly images the bolus injection of ^{99m}Tc -Sestamibi as it passes through the left ventricle of the heart.

Based on the reconstructed frames, the quantitative software (INVIA) analyzes the bolus and extraction of the radiopharmaceutical by the myocardium to calculate the Coronary Flow Reserve (CFR) by coronary artery. This information can be crucial to diagnose multi-vessel and microvascular disease and used to be only available for PET.

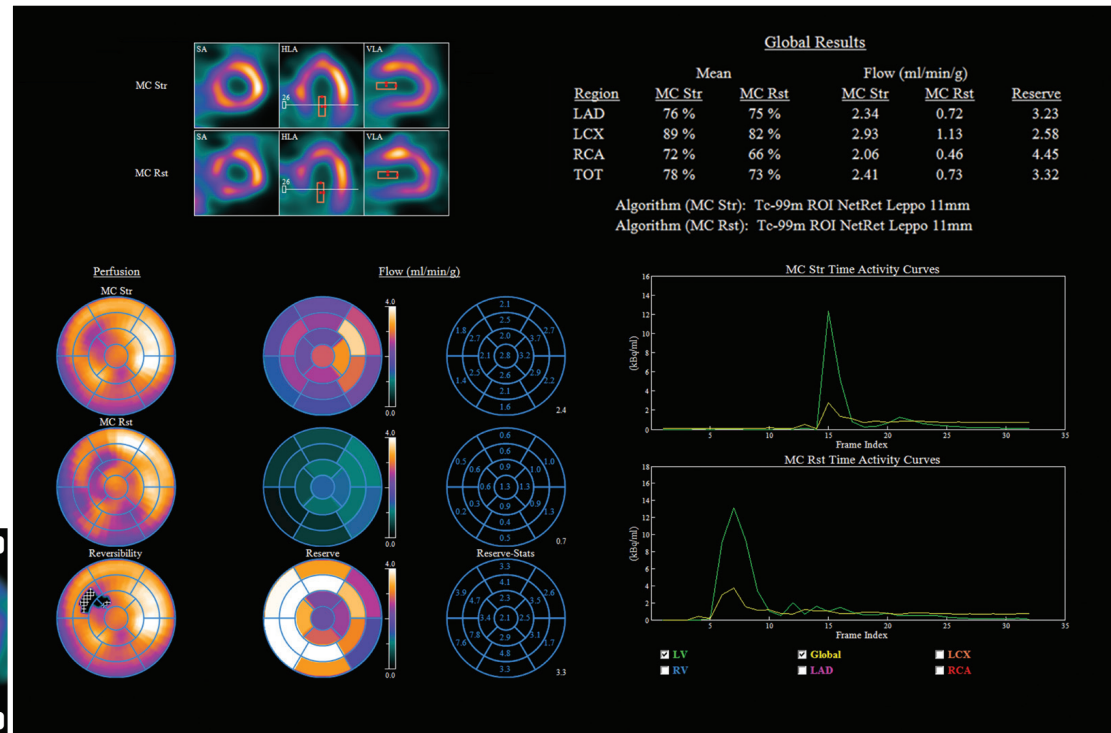
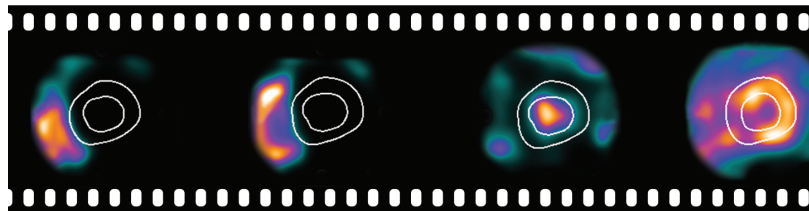

Where It All Starts...

Nine Digital CZT-Based Detectors

The CZT modules, which consist of CZT plus the electronics, are populated on a column with Tungsten collimators in front which channel the photons to the detector array. Using Tungsten collimators rather than lead eliminates potential lead X-ray which can degrade image quality.

The semiconductor, CZT, combined with our unique implementation of hardware and software, offers superior performance advantages over Sodium Iodide. The most important is the dramatic improvements in sensitivity and energy resolution. This gives the D-SPECT Cardio the ability to acquire low dose and simultaneous multiple energy studies.

Detector Configuration and ROI-Centric Scanning

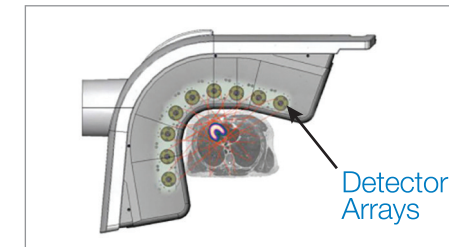

Comparison of Anger Scintillation and D-SPECT Cardio Solid State Technology

Anger Scintillator Technology

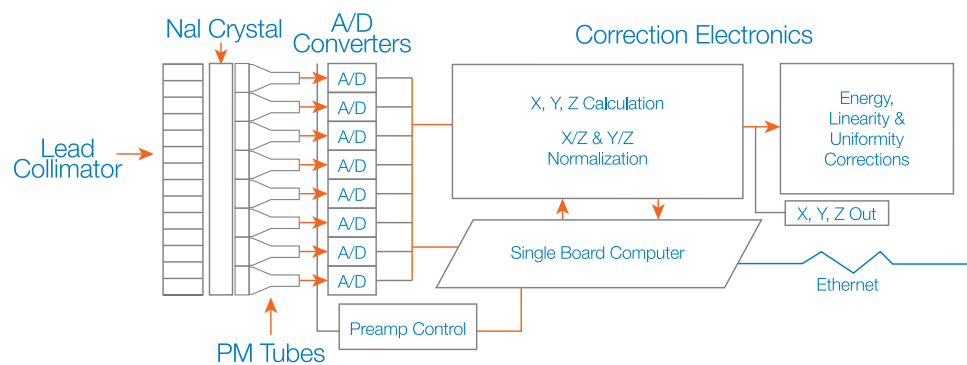

D-SPECT Cardio Solid State Technology

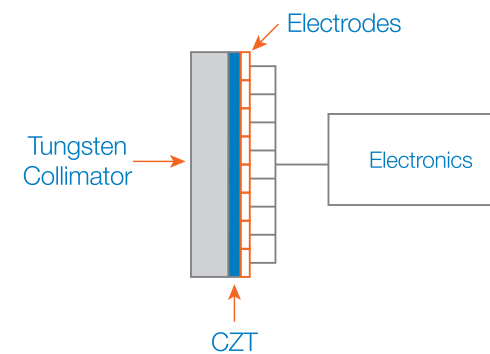

Gantry and Chair/Bed Design

The D-SPECT Cardio gantry design is simple, yet elegant. The system is counter-balanced for easy and smooth motions. Gantry positions are locked in place with electromagnetic brakes.

This unique design provides several advantages including:

- Small camera footprint.
- Open gantry design eliminates claustrophobia.
- Chair weight supports patients up to **1000 lb/454 kg** for morbidly obese patients.
- Flexible imaging chair/bed can be fully-upright, supine or anything in between to fit any clinical requirement. Patients can easily stabilize themselves as they stand or sit using the integrated grab bar.
- Unique gantry/detector design eliminates the need for the patient to place their left arm behind their head, improving patient comfort and reducing the chance of motion.
- Integrated on the detector is a touchscreen, where the operator can start the Pre-Scan positioning acquisition to:
 - Display the angle of the chair/bed and detector from the current and previous scan.
 - Display position of the heart within the field-of-view.



Displays the angle of the chair/bed and detector

Displays position of heart within the field-of-view

Acquisition and Advanced Reconstruction Algorithms

List Mode Acquisition

All acquisitions are acquired in list mode. This provides the capability to reframe the data, allowing the operator to change a number of different parameters.

- Adjust the R-Wave windows
- Apply scatter correction and process the multiple isotope acquisitions within seven different energy windows

Reconstruction

Our advanced reconstruction algorithm is based on an OSEM iterative algorithm with resolution recovery. Multiple reconstruction options are included within the reconstruction software.

The Model based reconstruction is a proprietary Spectrum Dynamics Medical algorithm and starts iterations from a Model of the LV instead of a uniform image.

This Model is calculated on initial OSEM iterations using identified myocardium contours to create a Model that will be used as “Initial Guess.” This method helps the reconstruction algorithm converge more quickly on an optimal solution and demonstrates a significant improvement of image properties and quality.

Reconstructed Cardiac Phantom



Clinical and Workflow Benefits



Fast results: The D-SPECT Cardio can acquire a complete gated SPECT study in as little as two minutes, improving clinical workflow, enhancing patient compliance and reducing the chance of patient motion.



Image quality: D-SPECT Cardio's count rich data sets combined with a proprietary reconstruction algorithm ensures optimal spatial resolution and exceptional image quality.



Dose reduction: The extremely high sensitivity of the D-SPECT Cardio detectors allows for dramatic reductions in injected dose. Patients and staff benefit from the lower radiation dose.



Simultaneous multi-isotope imaging (SDI): The exceptional energy resolution of CZT allows the detectors to acquire multiple energies at the same time with minimal down scatter. This makes simultaneous stress and rest imaging possible with perfect image registration, as well as new advanced multi-isotope protocols such as ^{123}I -mIBG or ^{201}Tl and $^{99\text{m}}\text{Tc}$ Sestamibi or Myoview.



Patient compliance: The open gantry design and the ability of the CZT columns to "swivel" back and forth allows the nine detectors, in an L shaped array, to acquire data from the patients Left Posterior Oblique (LPO) to Right Anterior Oblique (RAO) without the need to rotate the detectors around the patient. This eliminates the chance of an acquisition collision, pinch points or claustrophobia that moving detectors can cause.

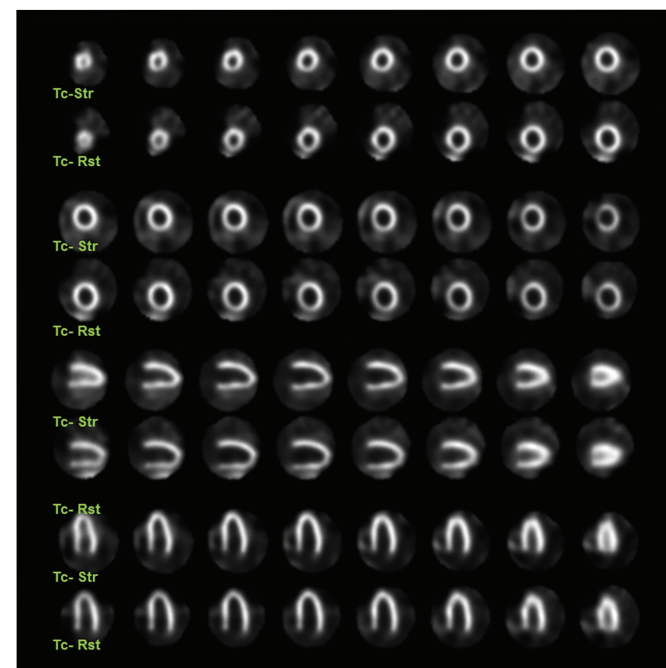

Two-minute gated SPECT study
with standard doses

Quantitative Software Packages

We offer the following quantitative software SPECT packages:

Cedars-Sinai
QGS + QPS

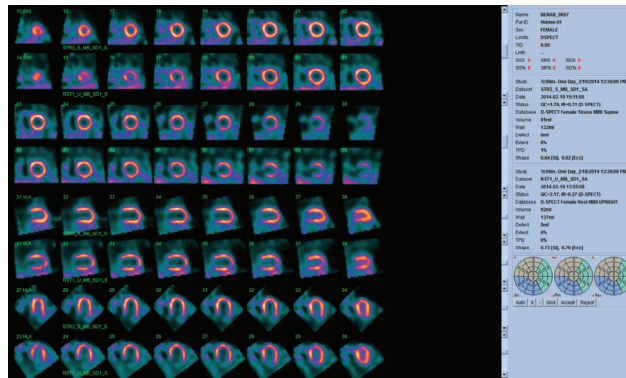

INVIA
4DM

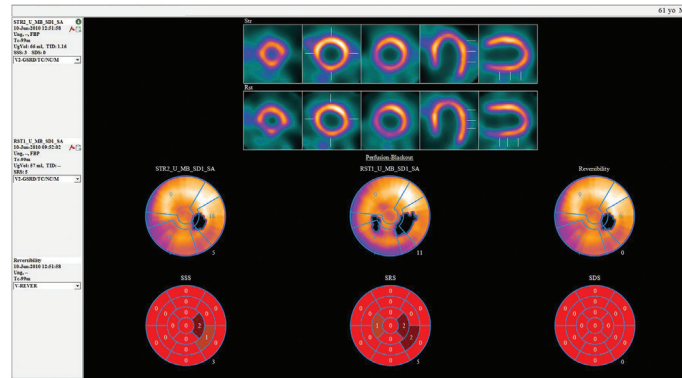

Syntermed
Emory Toolbox*

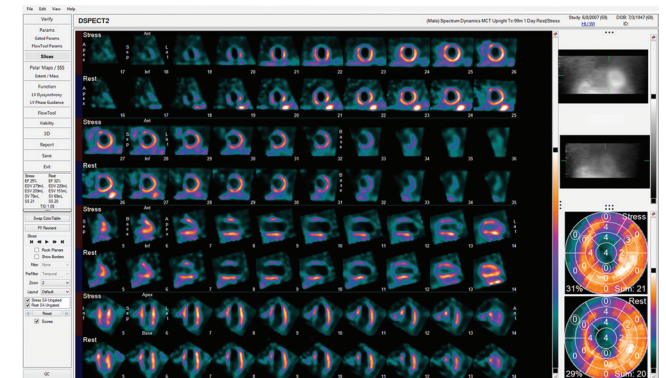

* Available in a Stand-Alone configuration only

Image Gallery

Note exceptional image quality and cavity definition.

Obese

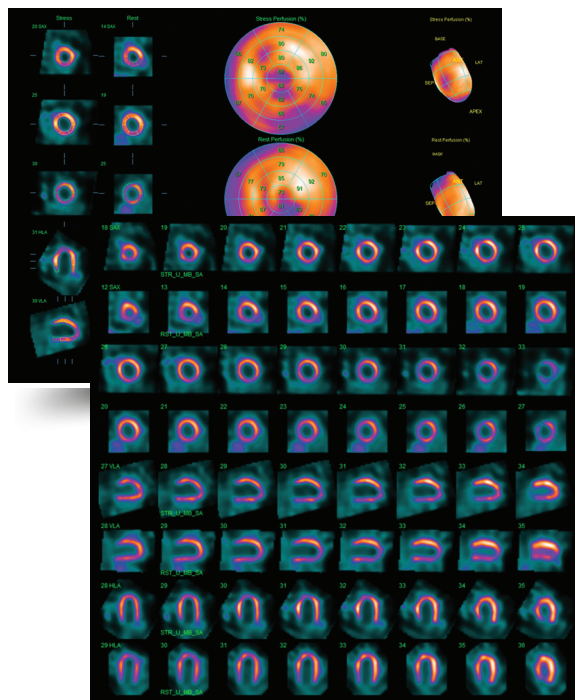

498 lb/226 kg BMI 75.7

Ultra-Low Dose

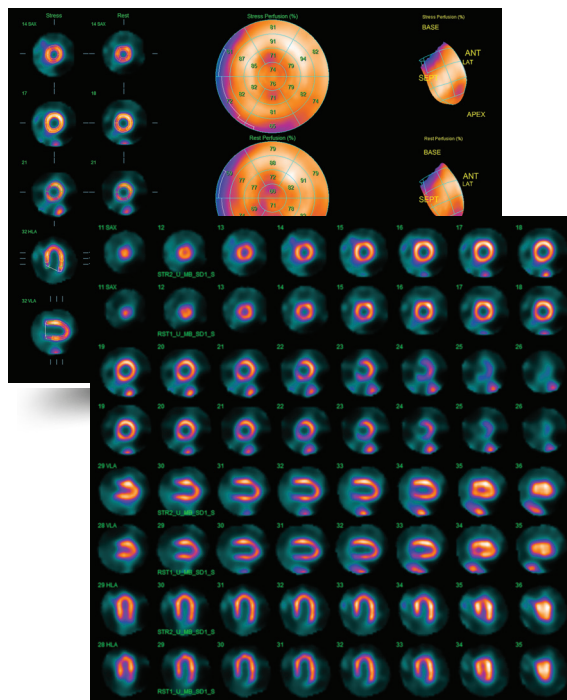

5 mCi/185 MBq ^{99m}Tc -Sestamibi

SDI

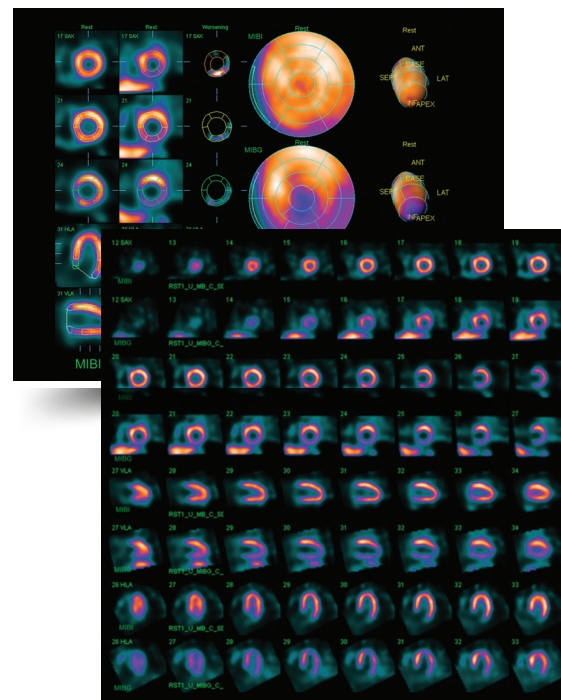

^{99m}Tc -Sestamibi + ^{123}I -mIBG

Quality Control

D-SPECT Cardio acquisition software incorporates a very simple to perform ⁵⁷Co based quality control acquisition that is executed daily and checks all key imaging parameters prior to clinical imaging. The procedure only takes a couple of minutes (varies with source strength) to accomplish.

Connectivity

The D-SPECT Cardio can connect and transfer data back and forth to a wide variety of HIS/RIS systems, PACS servers and other imaging devices using the DICOM standard. If you have questions regarding specific devices, Spectrum Dynamics Medical personnel can work on-site with your IT department to demonstrate connectivity and data transfer procedures.

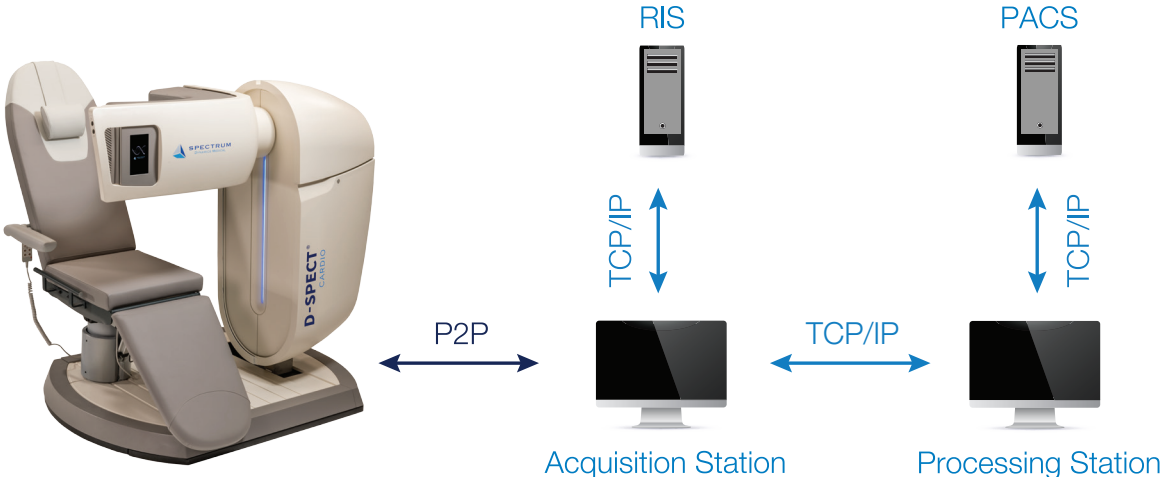

Daily QC Set-Up



Daily QC Results



Serviceability and Remote Diagnostics

The D-SPECT Cardio system was designed from the ground up with remote connectivity in mind. With the site's permission, regional specialists and/or factory trained engineers can log into your D-SPECT Cardio and perform almost any of the diagnostic technical functions a Field Service Engineer can complete on-site. Except for a part's replacement, it is often possible to correct or implement a workaround solution remotely, allowing imaging to continue while waiting for a technician to arrive on-site.

With a team of specialists who can assist you remotely and some of the most experienced service engineers throughout the world, we are able to correct most problems immediately and maximize your site's uptime.

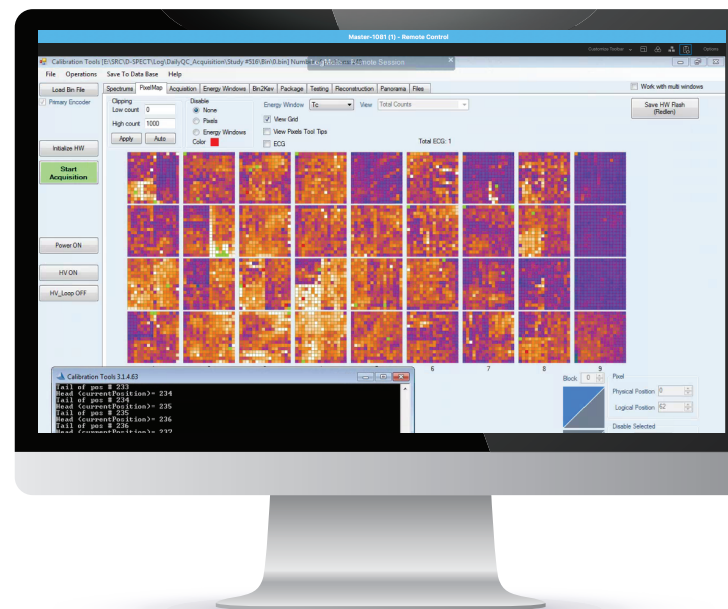
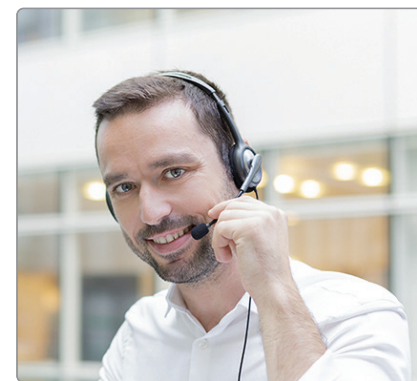



Spectrum Dynamics Medical, Inc.

301 N. Cattlemen Road, Suite 109
Sarasota, FL 34232
Tel: +1 941 256 3660
Fax: +1 941 256 3662
www.spectrum-dynamics.com

Spectrum Dynamics Medical, SA

Rue de Lausanne, 31
1110 Morges, Switzerland
Tel: +41 21 544 4710
Fax: +41 21 544 4711

Spectrum Dynamics Medical HK Limited

5 Canton Road
Suite 1729A Ocean Center
Tsim Sha Tsui, Kowloon, Hong Kong
Tel: + 852 580 14146
Fax: + 852 580 14151

Spectrum Dynamics Medical reserves the right to make changes in specifications or features shown herein without notice or obligation.

D-SPECT is a registered trademark of Spectrum Dynamics Medical.
© 2017 All rights reserved.

CE 0344